

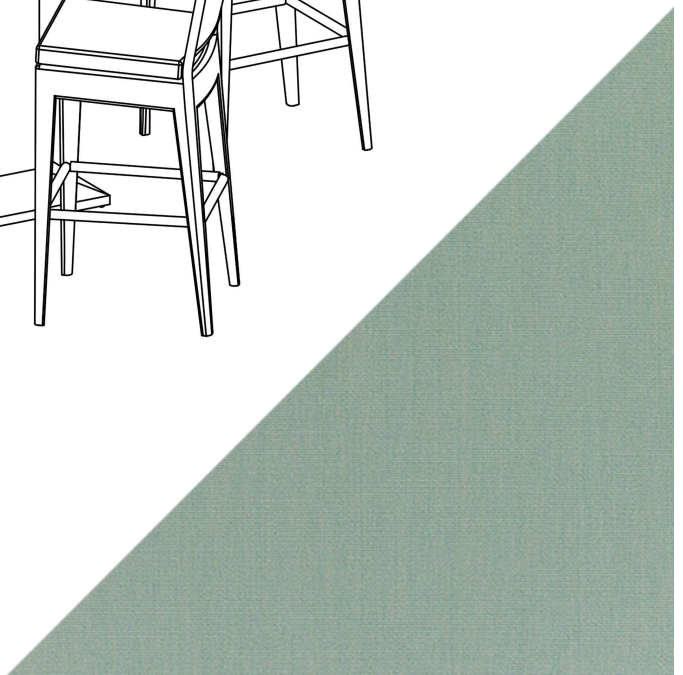

HARMONIA LIVING

District 5 Piece Bar Set - Canvas Spa HL-DIS-TS-5BCS-SP

Product Images

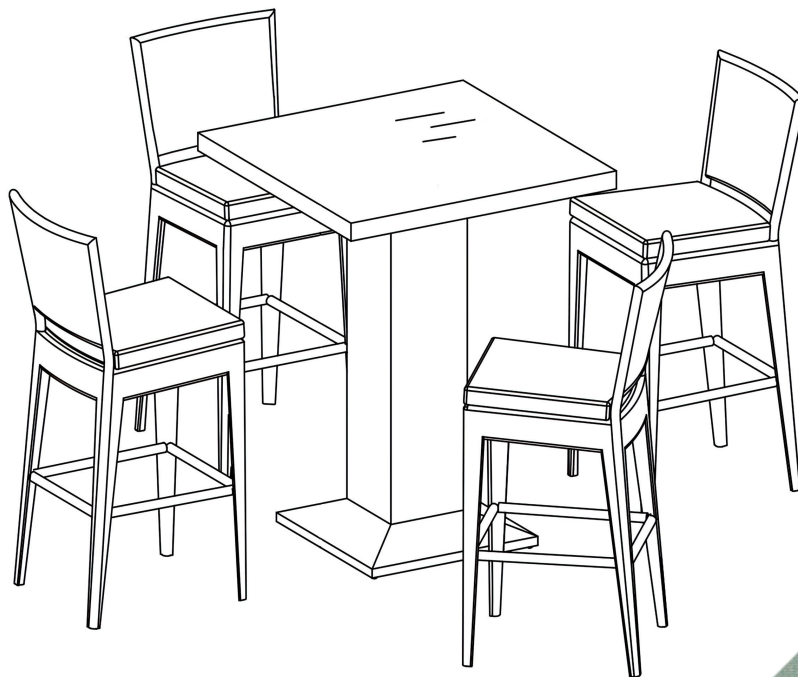

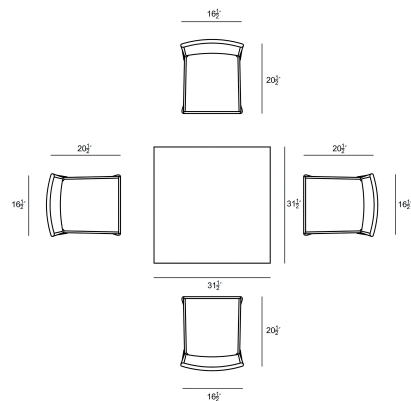
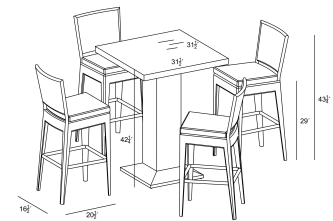
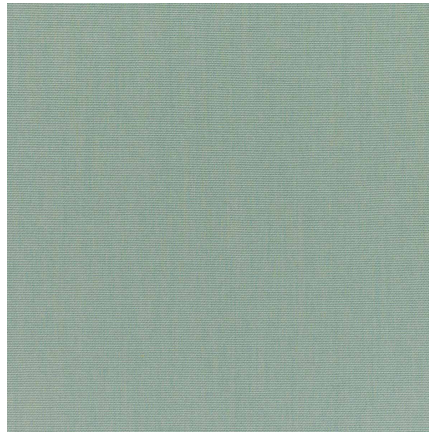
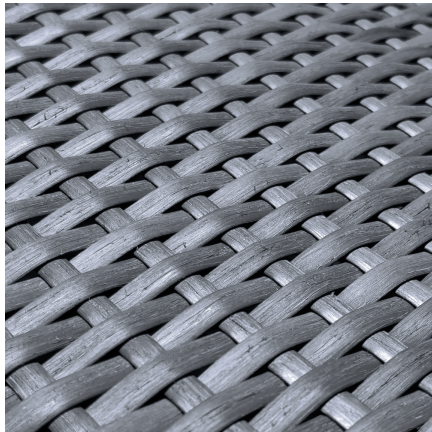
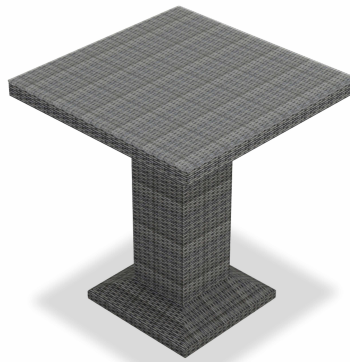

Description

For your next outdoor soiree, look no further than the District 5 Piece Bar Set by Harmonia Living. Perfect for seating up to 4 people, this set will bring added functionality and style to your patio! This collection's high arms, flat, woven design and weathered look give it a unique visual appeal, while sturdy, all-weather construction ensures lasting performance across the seasons. The wicker is made with durable High-Density Polyethylene (HDPE) and finished in a beautiful Textured Slate color, which gives it a natural feel. Its sturdy aluminum frames, double reinforced seats and fade resistant cushions are made to endure in any outdoor setting, rain or shine. The table is topped with frosted tempered glass, a finishing touch that is ideal for frequent use and cleaning. This set comes with 4 Bar Chairs and 1 Square 4-Seater Bar Table, perfect for your patio or outdoor lounge.

Includes

- 1x District 4-Seater Square Bar Table HL-DIS-TS-4BT-TOP
- 1x Glass Top HL-DIS-TS-4BT-BASE
- 4x District Bar Chair HL-DIS-TS-BC

Dimensions

- District 4-Seater Bar Table: 31.5L x 31.5W x 42.75H (60 lbs.)
 - Frame Height: 42.75
 - Under Table Height: 42
- District Bar Chair: 16.5L x 20.5W x 43.25H (15 lbs.)
 - Frame Height: 43.25
 - Seat Height (No Cushion): 28.75
 - Seat Height (With Cushion): 31.25
 - Back Height: 11.75

Features

- High-Density Polyethylene (HDPE) is a synthetic all-weather wicker made with virgin materials that provides resistance to fading and cracking. Wicker color is infused into the HDPE wicker for lasting durability.
- Wicker is hand-woven onto a thick gauge, powder coated aluminum frame that is lightweight, durable and corrosion resistant.
- Each seat is double reinforced for lasting durability
- Tempered glass top is extra strong and suitable for regular outdoor exposure.
- Plastic foot glides help to protect your patio from scratching and also to help keep the furniture protected from dirt or water that can accumulate on the patio.
- Cushions are made in America using American materials including Sunbrella, Outdura and Revolution performance fabrics which are easy to clean, are fade, stain, mildew resistant and carry a 5 year warranty.
- Machine washable cushion covers feature durable and frustration free YKK brand zippers for easy removal. Top and bottoms of our seat cushions are identical so they can be flipped if a stain gets on the cushion between machine washes.
- All cushions are sewn with PremoBond brand marine-grade UV treated thread made from high-quality mold, mildew, and rot resistant bonded polyester to ensure your cushions won't fall apart at the seams.
- Each seam is finished with overlock stitching for additional durability, reinforcement, weather proofing and to prevent the fraying of internal fabric edges during machine washing.
- American made CertiPUR-US® certified foam cushion inserts which are produced without harmful chemicals such as formaldehyde, ozone depleters, PBDEs, TDCPP or TCEP flame retardants and are free of mercury, lead, and other heavy metals to protect the planet as well as the health of you and your loved ones.
- Thick 2.5" foam cushion inserts creates a cushion that's firm enough to avoid bottoming out, but soft enough for comfort.
- Velcro belts are used to secure the cushion to the back of the frame.