



HARMONIA
LIVING

Avion 3 Piece Loveseat Set - Black HL-AVN-BK-3LSS

Product Images



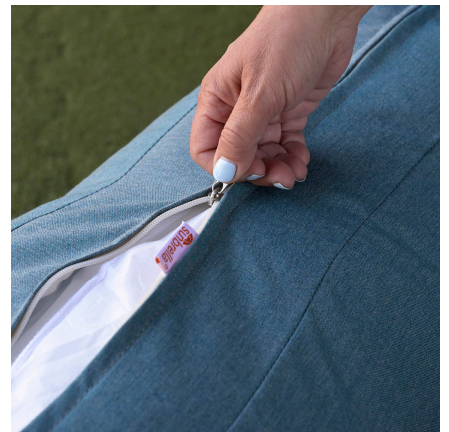
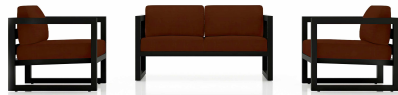
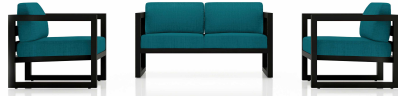

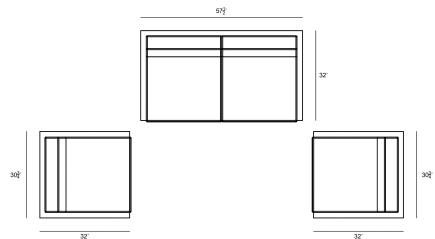
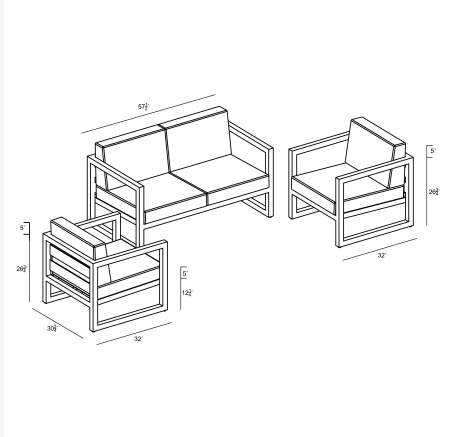
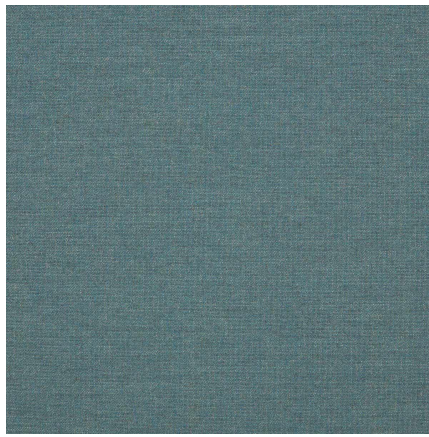
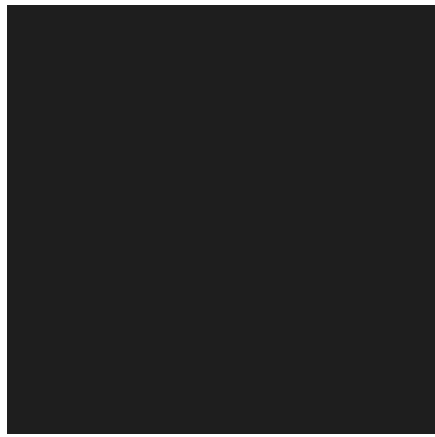

Description

An inspired blend of Midcentury Modernism and contemporary lines, the 3 Piece Avion Loveseat Set by Harmonia Living brings artful design to your outdoor space. The hallmarks of the collection include durable aluminum metalwork, a sleek silhouette, and extra-spacious deep seating. Stain-resistant Sunbrella® fabric cushions and weather-resistant powder-coated frames make Avion as sensible as it is stylish. If you wish to order this set through Harmonia Living's Quick Ship program, make sure to select a Quick Ship (QS) fabric before checkout! All cushions are made in the USA from Sunbrella, Outdura, and Revolution performance fabrics which carry a 5 year fade warranty.

Includes

- 1x Avion Loveseat - Black HL-AVN-BK-LS
- 2x Avion Club Chair - Black HL-AVN-BK-CC

Dimensions

- Avion Loveseat : 57.5L x 32W x 33H (35 lbs.)
 - Frame Height: 26.75
 - Seat Height (No Cushion): 12.25
 - Seat Height (With Cushion): 17.25
 - Back Height: 15.75
 - Arm Height: 26.75
- Avion Club Chair : 30.75L x 32W x 33H (34 lbs.)

- Frame Height: 26.75
- Seat Height (No Cushion): 12.25
- Seat Height (With Cushion): 17.25
- Back Height: 15.75
- Arm Height: 26.75

Features

- Durable, rust proof frames made from thick gauge aluminum with a high-quality powder coated finish that is appropriate for residential and commercial settings.
- Plastic leveling feet help to protect your patio and can be adjusted for uneven surfaces. They also help to keep the furniture protected from dirt or water that can accumulate on the patio.
- Cushions are made in America using American materials including Sunbrella, Outdura and Revolution performance fabrics which are easy to clean, are fade, stain, mildew resistant and carry a 5 year warranty.
- Machine washable cushion covers feature durable and frustration free YKK brand zippers for easy removal. Top and bottoms of our seat cushions are identical so they can be flipped if a stain gets on the cushion between machine washes.
- All cushions are sewn with PremoBond brand marine-grade UV treated thread made from high-quality mold, mildew, and rot resistant bonded polyester to ensure your cushions won't fall apart at the seams.
- Each seam is finished with overlock stitching for additional durability, reinforcement, weather proofing and to prevent the fraying of internal fabric edges during machine washing.
- American made CertiPUR-US® certified foam cushion inserts which are produced without harmful chemicals such as formaldehyde, ozone depleters, PBDEs, TDCPP or TCEP flame retardants and are free of mercury, lead, and other heavy metals to protect the planet as well as the health of you and your loved ones.
- Thick 4.5" foam seat cushion inserts plus additional layers of 1" of quick-drying Dacron on the top and bottom to help wick away moisture. This combination of layers creates the "Goldilocks" of cushions, firm enough to avoid bottoming out but soft enough for comfort.
- Back cushions are filled with 100% polyester fill fibers for a cloud-like back rest. The insert is sewn shut in a mesh incasing to keep the filling clean and easy to unstuff.
- Cushion ties are sewn to the back of each seat cushion to secure them in place to the frame.