



HARMONIA
LIVING

2-Seater Dining Bench Cushion HL-CUSH-2DB

Product Images



2-Seater Dining Bench Cushion

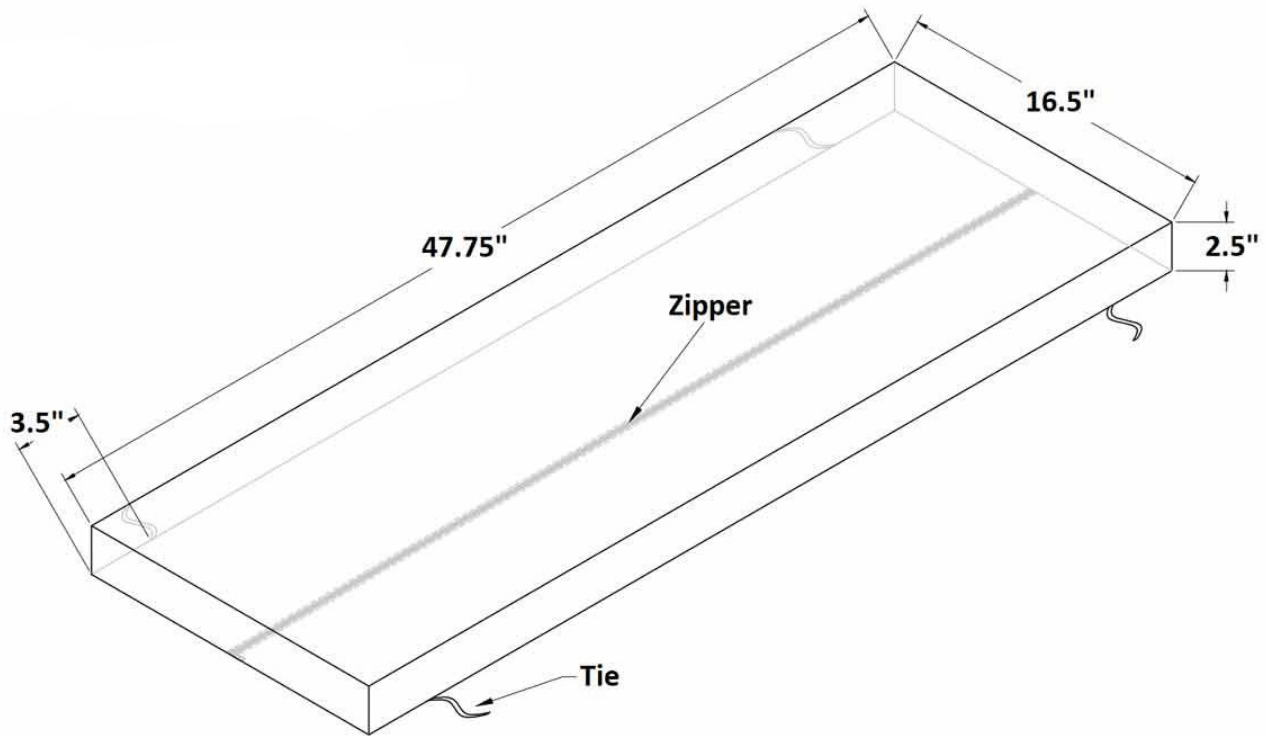

Description

Our seat cushions are made in America using high-quality materials including Sunbrella, Outdura, and Revolution performance fabrics. Covers are easy to clean, featuring durable and frustration free YKK brand zippers for easy removal. Our cushions are fade, stain, and mildew resistant, and for added peace of mind, carry a 5-year limited warranty. All cushions are sewn with PremoBond thread and seams are finished with overlock stitching for additional durability, reinforcement, and weather proofing to prevent fraying of fabric edges during machine washing. Inserts are made with CertiPUR-US® certified foam, produced without harmful chemicals such as formaldehyde, ozone depleters, PBDEs, TDCPP or TCEP flame retardants and are free of harmful materials such as mercury, lead, and other heavy metals. Foam is firm enough to avoid bottoming out but soft enough for comfort thanks to 2.5" inserts.

Includes

- 1x Cushion Cover - 2-Seater Dining Bench (HL-CVR-2DB)

Dimensions

- Cushion: 48"L x 17"W x 3"H

Features

- Machine washable cushion covers feature durable and frustration free YKK brand zippers for easy removal. Top and bottoms of our seat cushions are identical so they can be flipped if a stain gets on the cushion between machine washes.
- All cushions are sewn with PremoBond brand marine-grade UV treated thread made from high-quality mold, mildew, and rot resistant bonded polyester to ensure your cushions won't fall apart at the seams.
- Each seam is finished with overlock stitching for additional durability, reinforcement, weather proofing and to prevent the fraying of internal fabric edges during machine washing.
- American made CertiPUR-US® certified foam cushion inserts which are produced without harmful chemicals such as formaldehyde, ozone depleters, PBDEs, TDCPP or TCEP flame retardants and are free of mercury, lead, and other heavy metals to protect the planet as well as the health of you and your loved ones.
- Thick 2.5" foam cushion inserts creates a cushion that's firm enough to avoid bottoming out, but soft enough for comfort.
- Cushion ties are sewn to the back of each seat cushion to secure them in place to the frame.