



HARMONIA LIVING

CUSHION COVER - 29" Single Seat Back Cushion HL-CVR-29B

Product Images

29" Back Cushion

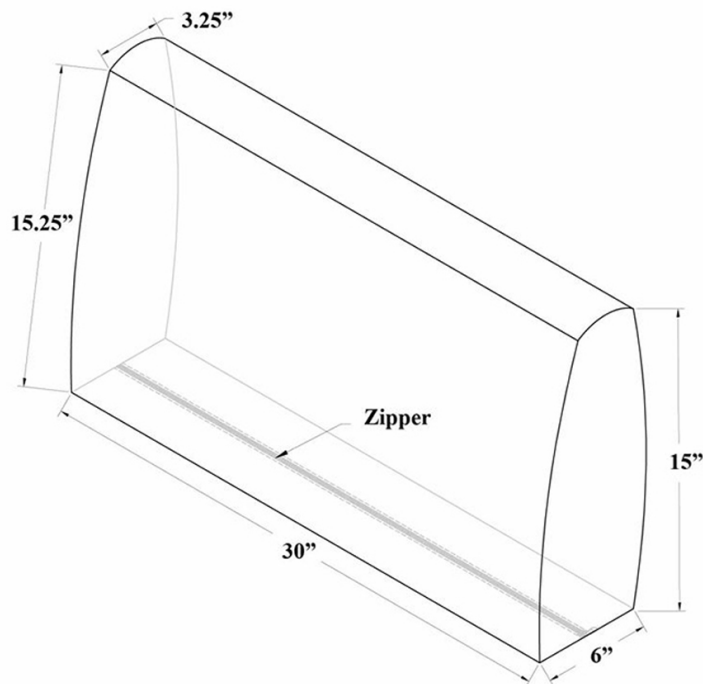

Description

Our back cushions are made in America using high-quality materials including Sunbrella, Outdura, and Revolution performance fabrics. Cushion covers are easy to clean, featuring durable and frustration free YKK brand zippers for easy removal. Our cushions are fade, stain, and mildew resistant, and for added peace of mind, carry a 5-year limited warranty. All cushions are sewn with PremoBond thread and seams are finished with overlock stitching for additional durability, reinforcement, and weather proofing to prevent fraying of fabric edges during machine washing. Inserts are made with CertiPUR-US® certified foam, produced without harmful chemicals such as formaldehyde, ozone depleters, PBDEs, TDCPP or TCEP flame retardants and are free of harmful materials such as mercury, lead, and other heavy metals. The insert is sewn shut in a mesh incasing to keep the filling clean and easy to unstuff. Back cushions are filled with 100% polyester fill fibers for a cloud-like back rest.

Includes

- 1x Cushion Cover - 29" Single Seat Back (HL-CVR-29B)

Dimensions

- Cushion Cover: 30"L x 15"W

Features

- Machine washable cushion covers feature durable and frustration free YKK brand zippers for easy removal. Top and bottoms of our seat cushions are identical so they can be flipped if a stain gets on the cushion between machine washes.
- All cushions are sewn with PremoBond brand marine-grade UV treated thread made from high-quality mold, mildew, and rot resistant bonded polyester to ensure your cushions won't fall apart at the seams.
- Each seam is finished with overlock stitching for additional durability, reinforcement, weather proofing and to prevent the fraying of internal fabric edges during machine washing.